

FOXON

OPRAVY, PRODEJ A ŠKOLENÍ
PRŮMYSLOVÉ AUTOMATIZACE

FIOT FOXON INTERNET
OF THINGS



FOXON s.r.o.

IQRF & INDUSTRY 4.0

Ing. Jaromír Peterka, CEO

10 Over 10 years on the market

📈 Economics growth since 2006

📄 Represents over > 30 suppliers

🤝 Over 1000 customers

📍 Office in Liberec, Czech Republic

📄 ISO 9001:2008





Smart Manufacturing IoT Platform

ThingWorx™
A PTC® Business

**INDUSTRY 4.0
& IoT READY**



6 000 employees
32 000 active customers
\$1.3B software company, headquartered in Boston
Recognized leader in CAD, PLM, Service, ALM,
Internet of Things and Augmented / 3D / Virtual Reality

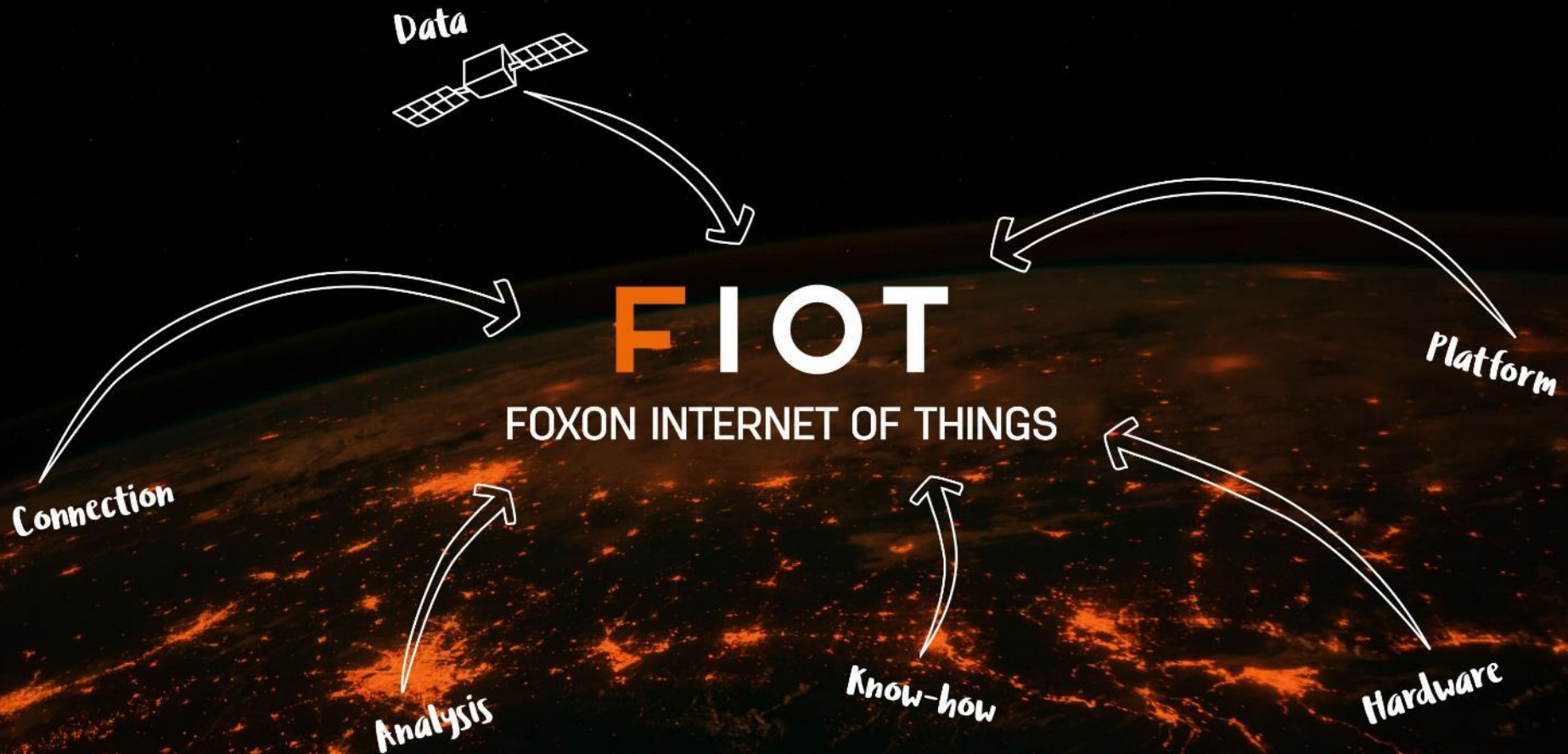

FOXON & FIOT

**INDUSTRY 4.0
& IoT READY**



FOXON & FIOT

**INDUSTRY 4.0
& IoT READY**

Interactive



FOXON & FIOT

**INDUSTRY 4.0
& IoT READY**

Information
ALL-IN-ONE



Augmented Reality

INDUSTRY 4.0
& **IoT READY**

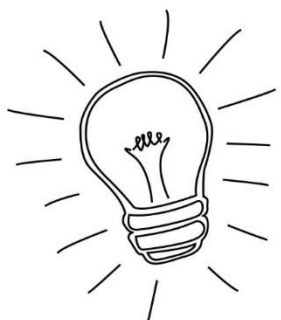

Practical use
of augmented reality,
AWESOME!



Main FIOT condition monitoring areas

- Power consumption & quality
- Device voltages & currents
- PROFINET & PROFIBUS networks
- Temperatures
- Vibrations
- Liquid quality / level
- Pressures, flow rates, speeds
- Advance device log analytics
- Preventive maintenance data
- Many more...

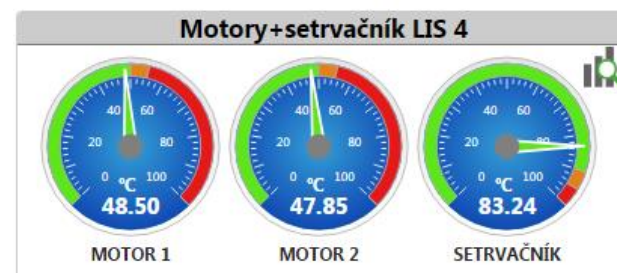
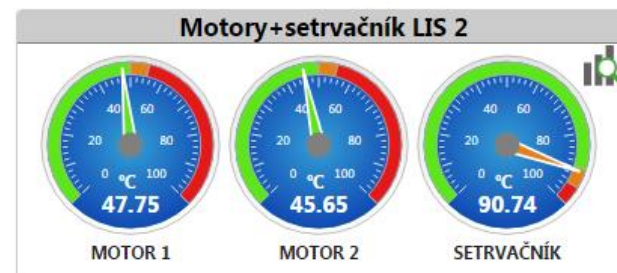
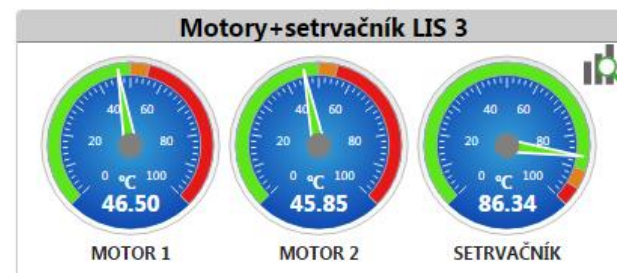



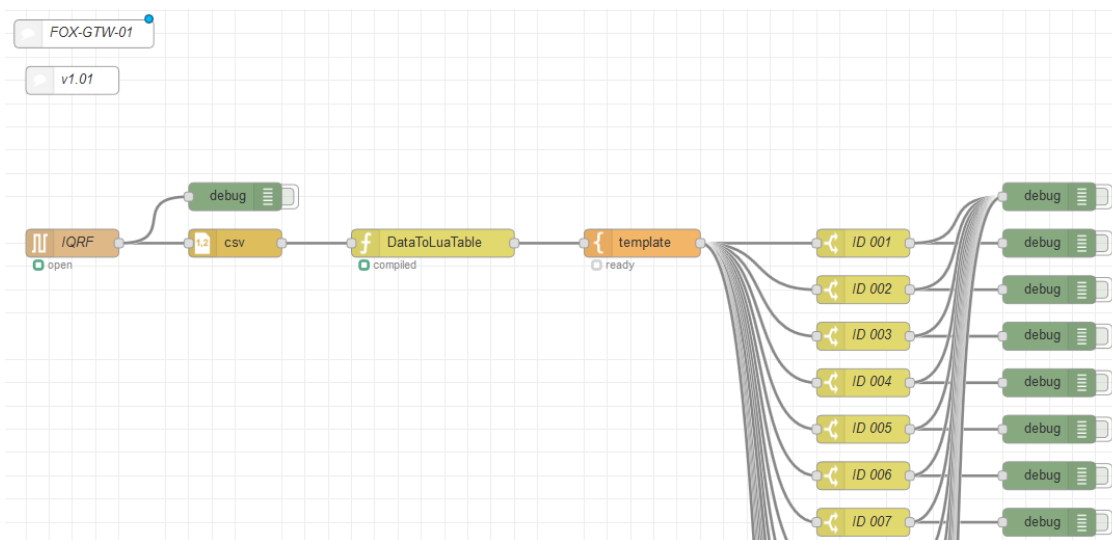

FOX-GTW-01

CloudGate by Option as IQRF GateWay

LuvitRED



Profibus cable monitoring via IQRF

-  Alerts
-  Dieselagregát
-  Rozvaděče
-  Profibus
-  Profinet

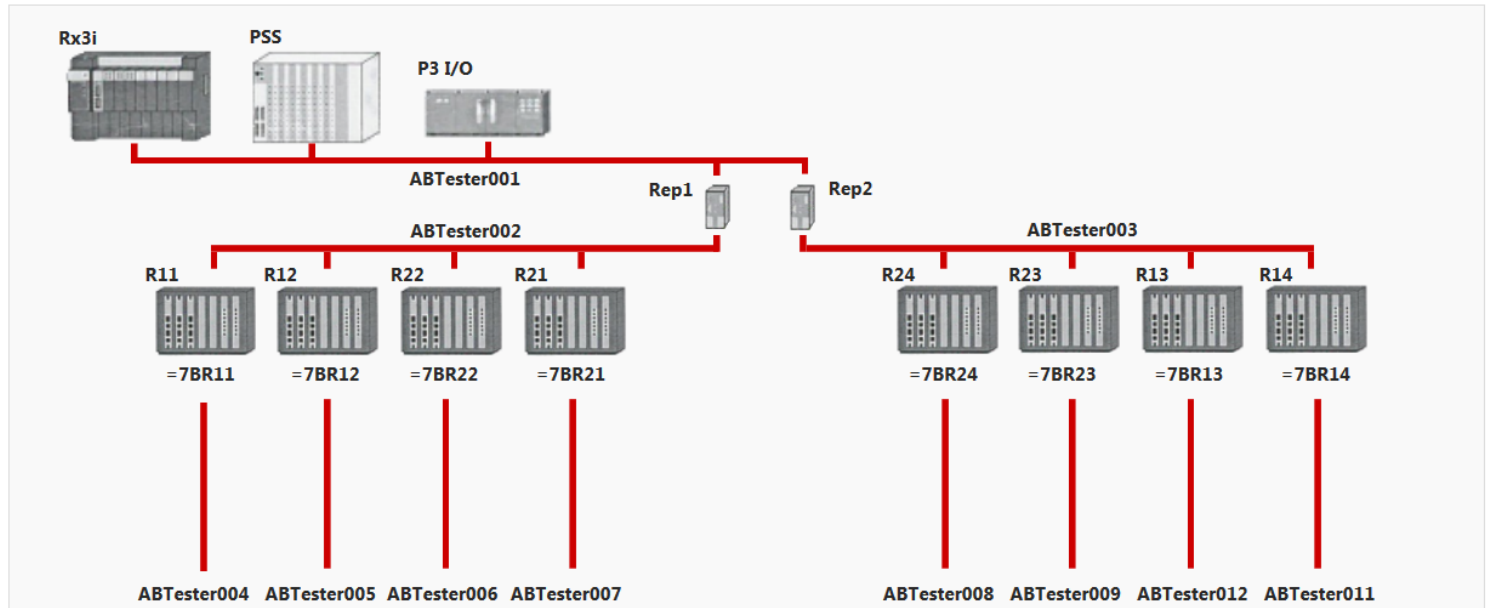

FIOT made by **FOXON** powered by  thingworx



AB-Tester-01



AB-Tester-01



- IQRF module DCTR-76D
- Permanent monitoring (max/min)
 - Voltage 0 – 35VDC
 - Current 0-20mA
- Data upload 5-250sec
- 17,8kHz / single channel, 8,4kHz / 2 channels



Profibus cable monitoring via IQRF



- Alerts
- Dieselagregát
- Rozvaděče
- Profibus
- Profinet

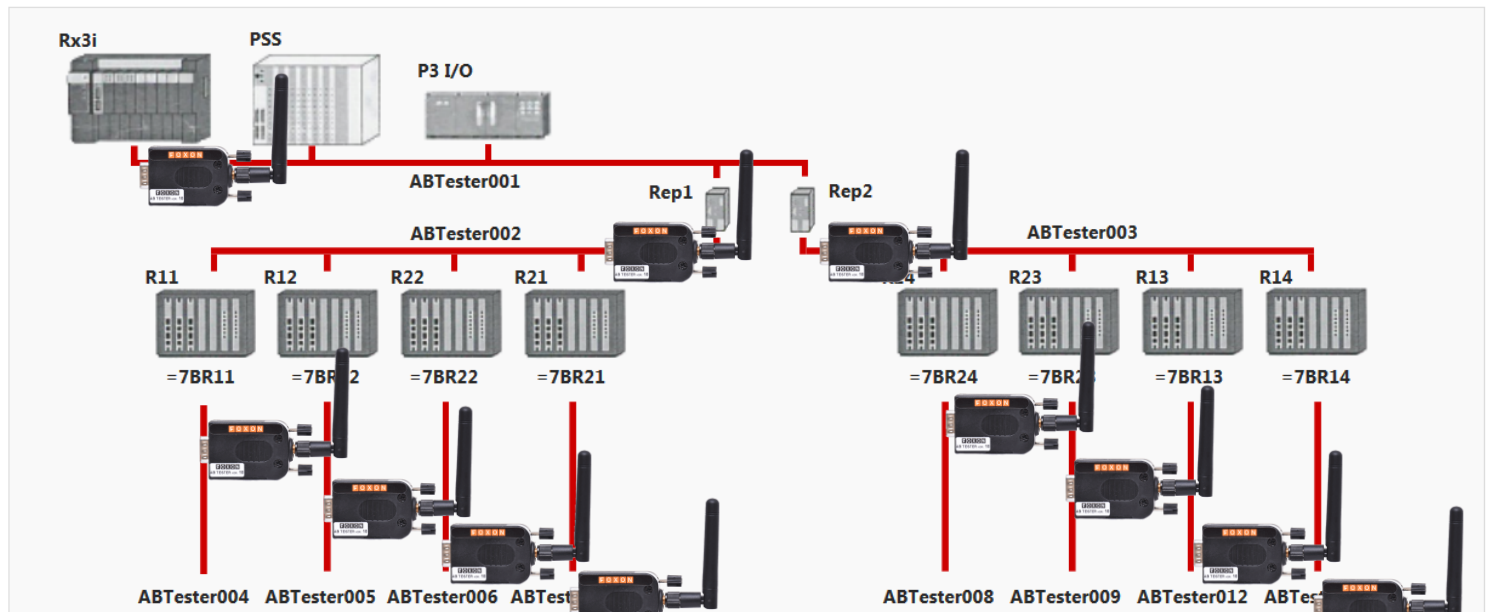

Profibus cable monitoring via IQRF

ABTester001

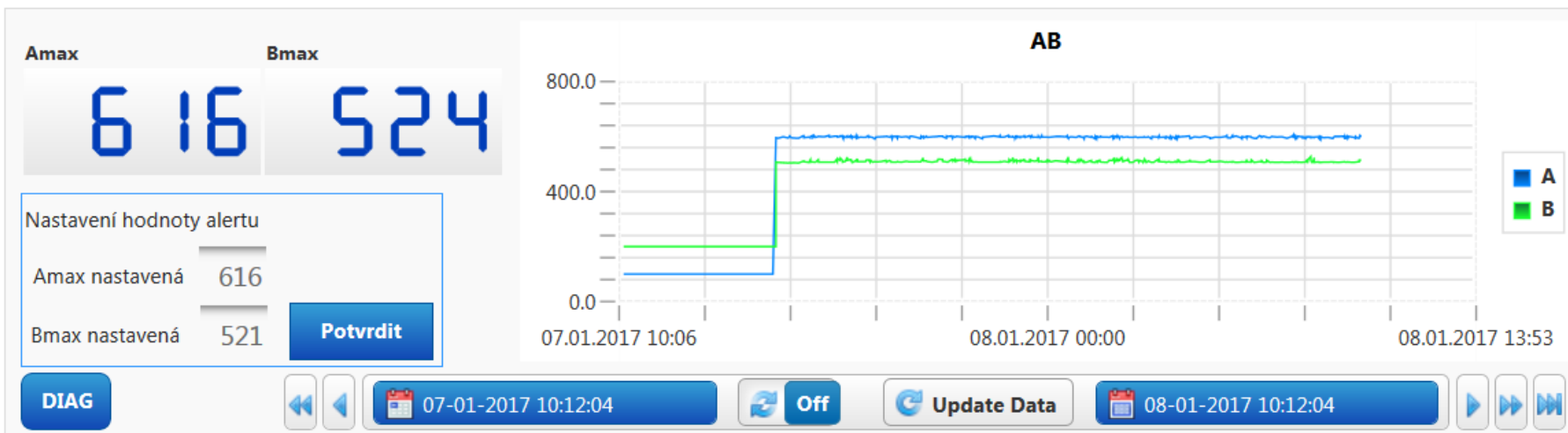

IQRF Power socket



- IQRF module DCTR-76DA
- Max 16A/230VAC
- Max 250 sockets in one network



More ideas come every day...





OPRAVY, PRODEJ A ŠKOLENÍ
PRŮMYSLOVÉ AUTOMATIZACE

FIOT FOXON INTERNET
OF THINGS

Thank you

Ing. Jaromír Peterka, CEO

jaromir.peterka@foxon.cz

FOXON s.r.o.

Česká 615/25, 463 12 Liberec 25, Czech Republic

Tel.: (+420) 484 845 566, foxon@foxon.cz

www.foxon.cz | www.fiot.cz | www.profibus-profinet.cz